

# Boston II

## Technische fiches

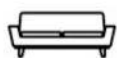

Het model Boston II heeft strakke vormen en lijnen. Het model heeft dezelfde basis als het model Boston, maar zonder de 3-hoekige kussens in de armen. Dankzij verschillend beschikbare zitdiepte's en een optionele hoofdsteun biedt het model een hoog comfort. Het model is verkrijgbaar in fauteuil, canapé, hoek en chaise longue. Deze elementen zijn individueel aanpasbaar en combineerbaar, zo stel je zelf je ideale zetelcombinatie samen.



### STAP 1

Kies uw model



### STAP 2

Kies uw zitplaatsen  
met / zonder relax

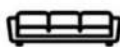

### STAP 3

Bepaal uw  
exacte maatvoering



### STAP 4

Kies uw zitcomfort



### STAP 5

Kies uw stof of leder



1

## Canapé

### Voorzichten

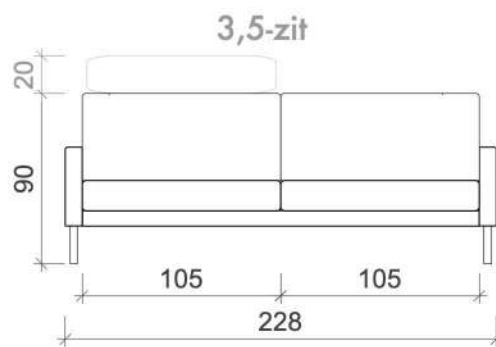
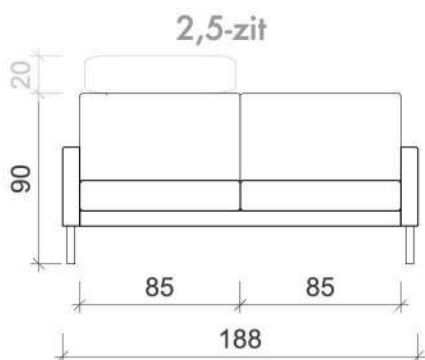
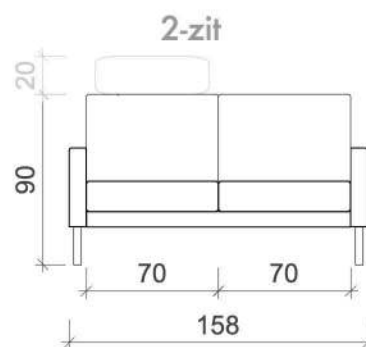
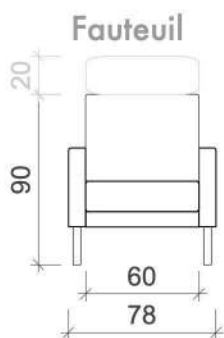

### Zijaanzichten

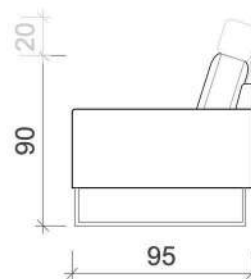
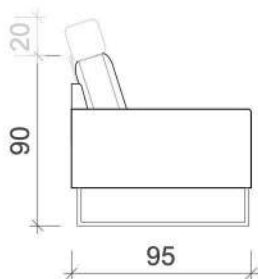

### Vooranzichten

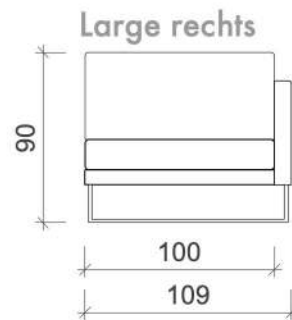
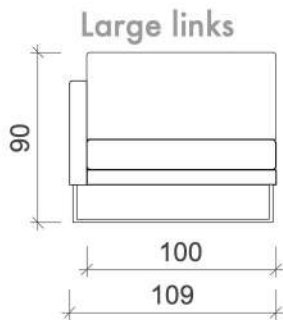
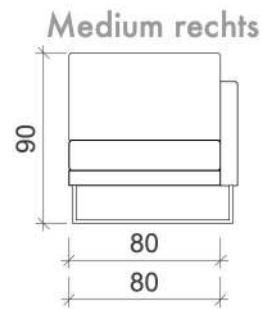
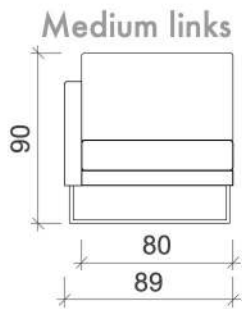

### Zijaanzichten

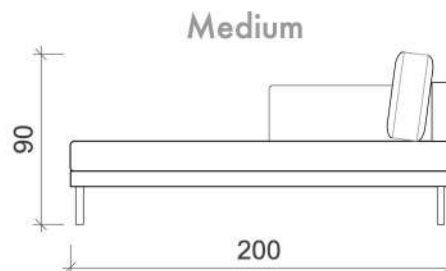
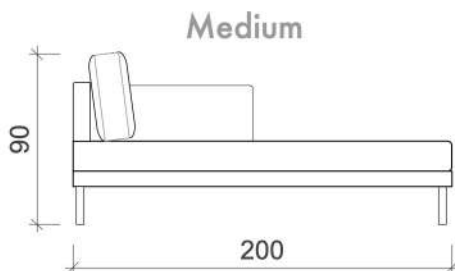
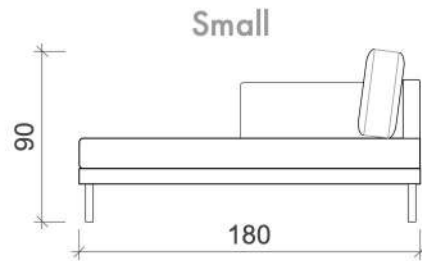
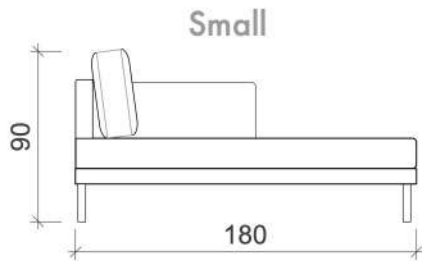

### Voorzichten

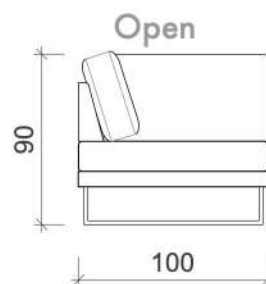
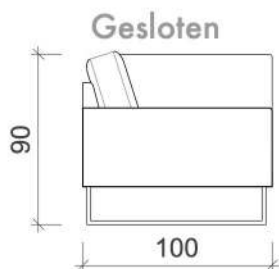

### Zijzichten

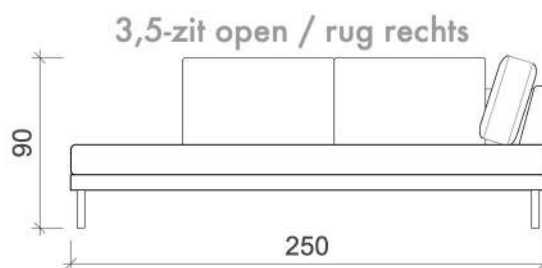
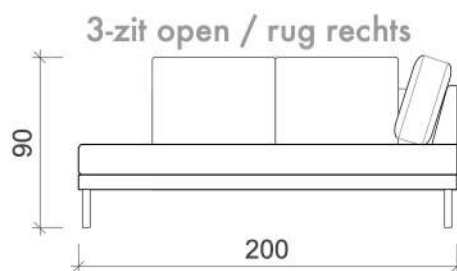
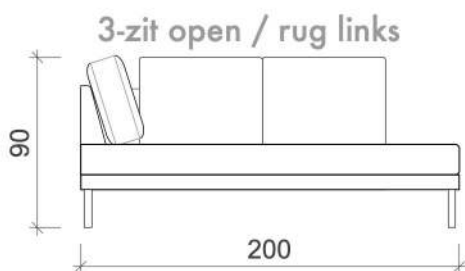
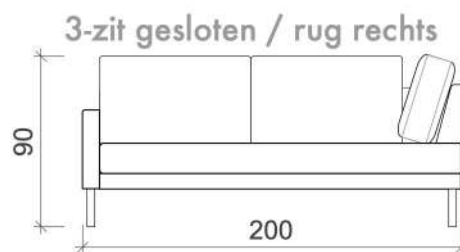

### Voorzichten

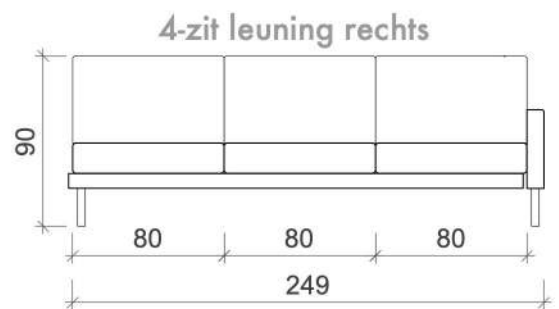
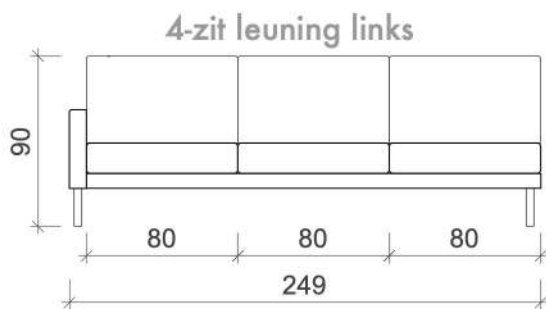
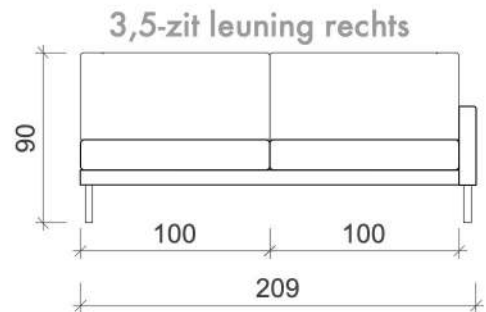
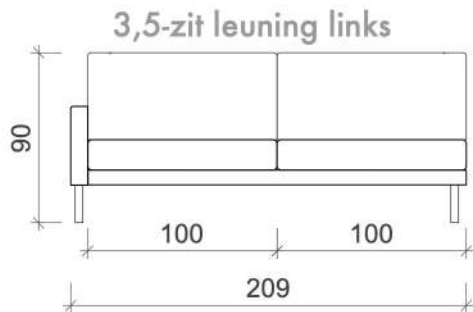
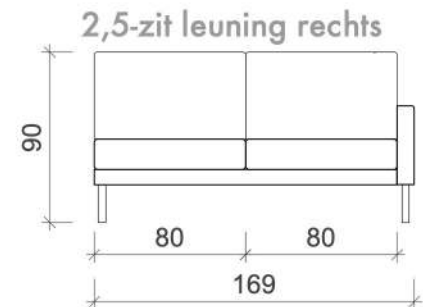
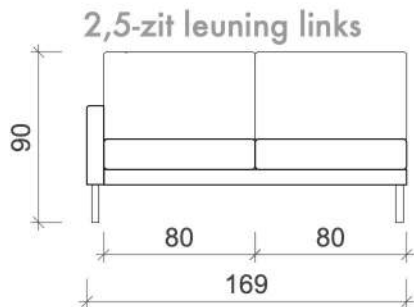
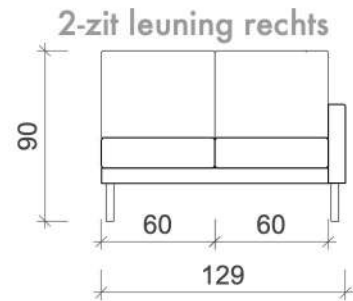
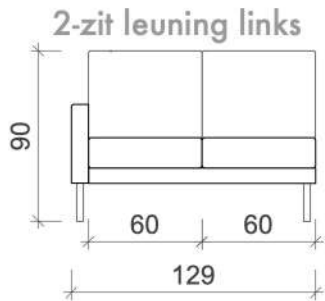

### Zijaanzichten

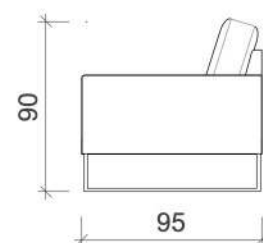
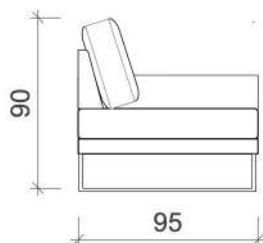

## 5 Poef

### Voorzichten

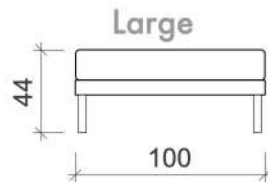
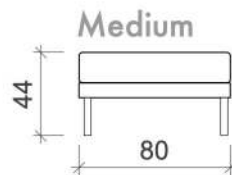
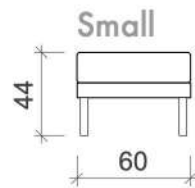

### Bovenaanzichten

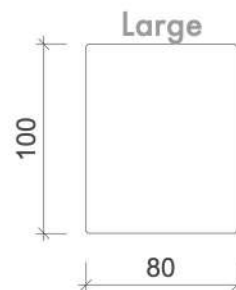
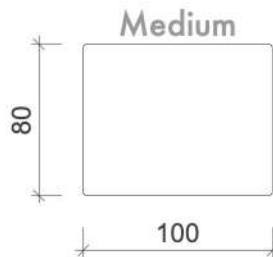
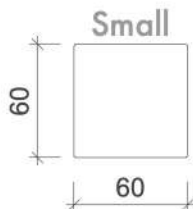

## Voorbeeld opstelling

### Bovenaanzicht

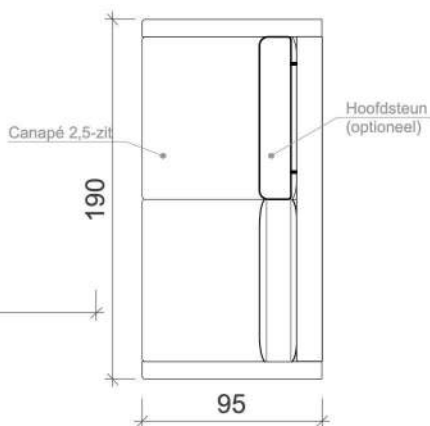
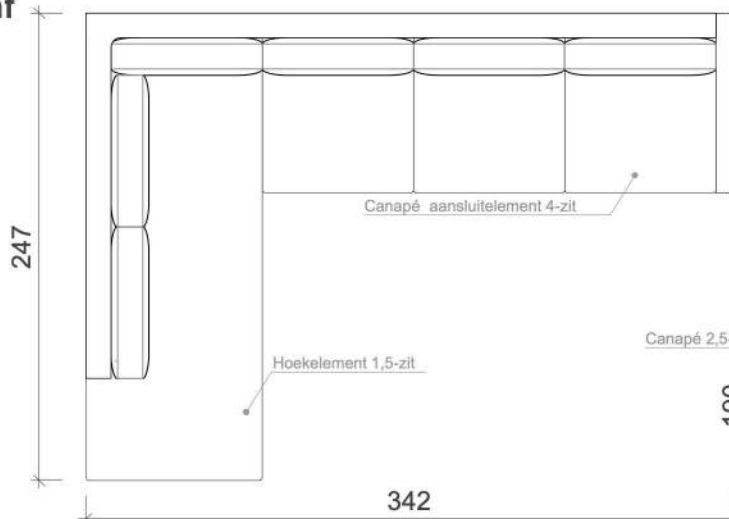

### Voorzichten

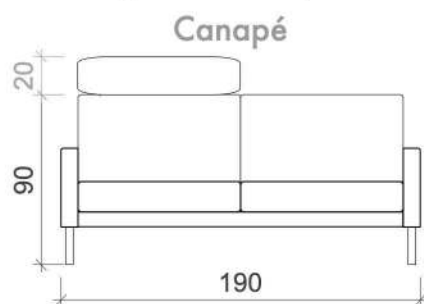
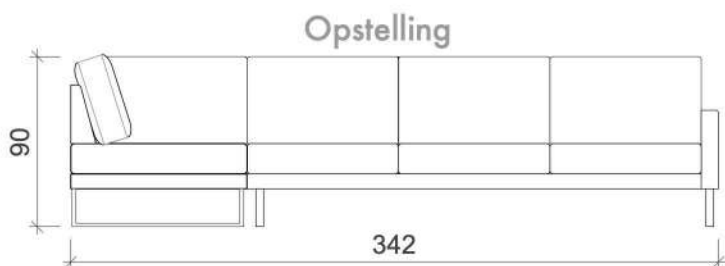

### Zijaanzichten

